

回路と電流・電圧

NO. 2

名前

/ 8 点

◆ 次の空欄にあてはまる電流の大きさを、単位に注意して答えなさい。

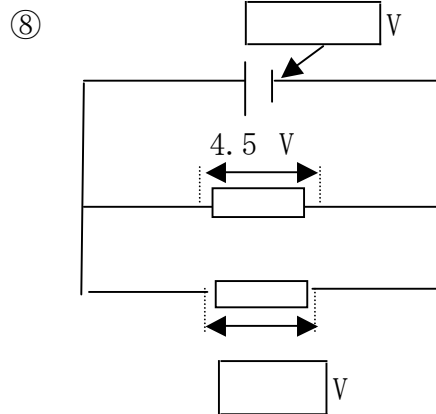
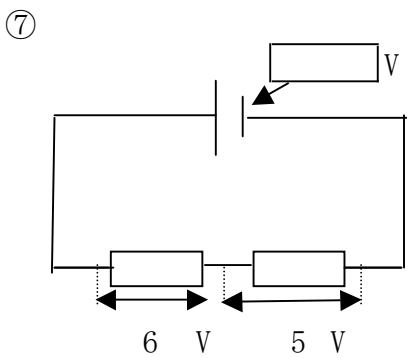
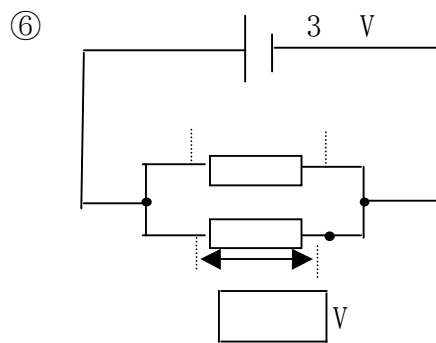
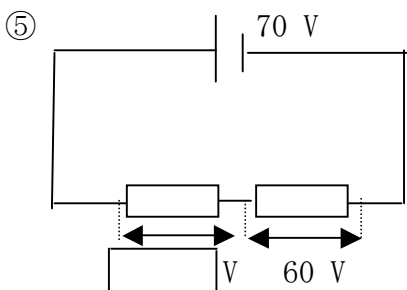
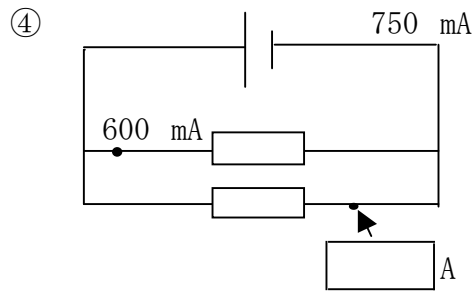
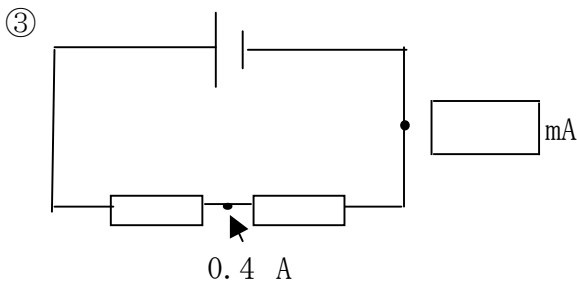
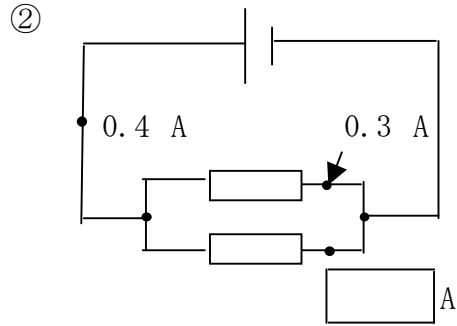
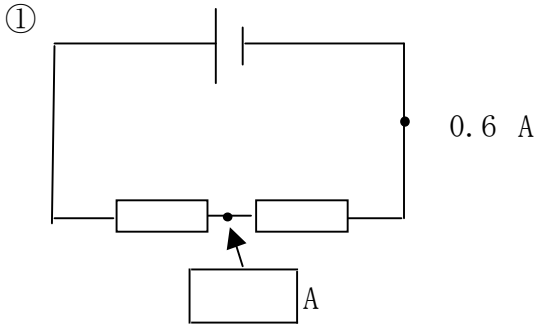

解答

① 0.6 A ② 0.1 A ③ 400 mA ④ 150 mA

⑤ 10 V ⑥ 3 V ⑦ 11 V ⑧ 4.5 V

(2カ所とも)